

ZRL
LED KASA SİSTEMLERİ

LED
KASALAR

Ürün Kataloğu

Ledli Aydınlatma Teknolojileri Üzerine Alüminyum Boş Kasa Sistemleri



Hakkımızda

2000 yılında Led aydınlatma teknolojilerinin ana dallarından biri olan PCB sektöründe 17 yıl tecrübe edinmenin yanı sıra, kalıp sektöründe aynı yıllarda tecrübeler edindik. Bu süreçte led aydınlatma sektörünü araştırmalarımız sonucunda ledin kendisi ve kasasının Çin'den ithal edildiğini fark ederek, Türkiye'de bu sektöre yeterli hizmet verilmediğini gördük. Edinmiş olduğumuz tecrübelerimizi birleştirerek, led aydınlatma teknolojilerinin kasaya ihtiyacı olduğunu farkettilik. Ledli ürünlerin enerji tasarrufunun yanı sıra kaliteli ışık gücünde tercih noktasında önemli rol oynadığını belirtmek isteriz.

Sektöre ilk atılımımız 2007 yılında özel yatların led aydınlatması olmuştur.

2015 yılında kendimize ve sektöre özgü kalıp yatırımlarımız ile ana sloganımız olan 'Yaşamın olduğu her yerde varız' ön görüşü ile üretmeye ürün portföyümüzü genişletmeye başladık. Yurt içi ve yurt dışı seyahatleri yaparak sektörün fikir ve tecrübelerini öğrendik.

2018 yılında kendi markamız olan LED KASALAR firmamızı kurduk . 2019 yılında Faaliyet alanımızı genişleterek ANKARA bayimiz ÖZDE LED KASALAR'ı sektöre kazandırdık.

2021 yılında ZRL LED KASA SİSTEMLERİ İTHALAT ve İHRACAT LTD.ŞTİ. firmamızı da bünyemize dahil ederek faaliyetlerimize hız kazandırdık.

Başlıca ürün gruplarımız;

Enjeksiyon kasa çeşitlerimiz(projektör, sokak lambası, kanopi, yüksek tavan..vb.)

Linear profiller(led bar, sıva altı ve sıva üstü linear,wallwasher,etanj..vb.)

Dekoratif linear(halka, davul,kare,üçgen..vb.)

Ürün gruplarımızı geliştirerek led aydınlatma teknolojileri üzerine alüminyum boş kasa ve aksesuar tedariki sağlamaktayız.

Yurtiçi ve yurtdışı ilgi odağı olan ürün gruplarımızın yanı sıra her yıl yeni ürün kalıpları yaparak ve kendimizi geliştirerek sektöre hizmet vermekteyiz

Avize
Profil
Grupları



Linear
Profil
Grupları

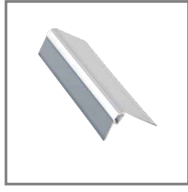
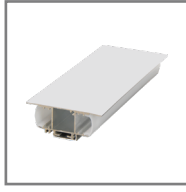
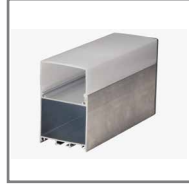
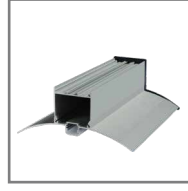
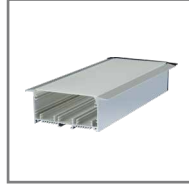
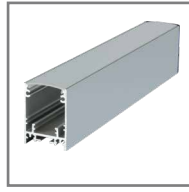

Wallwasher
Grupları

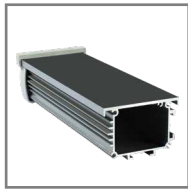

Etanj
Grupları



Bant
Armatür
Grupları



Polikarbon
Linear
Grupları



Trimles
Grupları

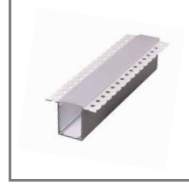

Projektör
Grupları



Sokak
Armatürü
Grupları



Yta
Kanopi
Grupları



Dekoratif
Grupları

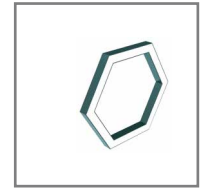
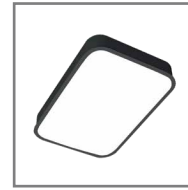

LKS-LNR-AVZ-1



LKS-LNR-AVZ-2

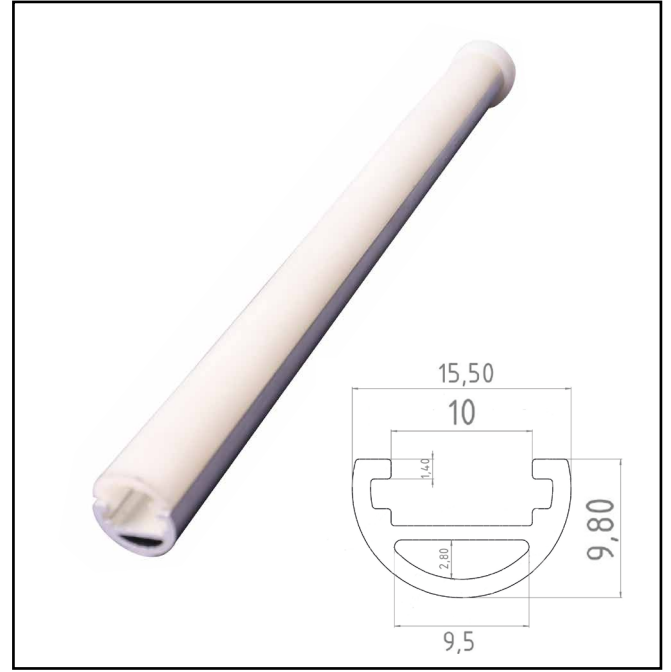

LKS-LNR-AVZ-3

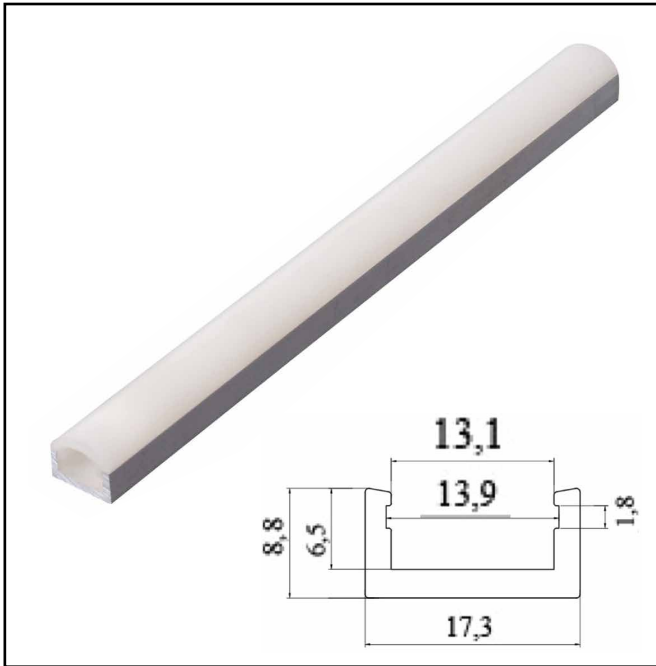

LKS-LNR-AVZ-4



ÖZELLİKLER

KASA	Eloksal Ekstruzyon Alüminyum
DİFFÜZÖR	Sarmaz Slikon
İŞİMA AÇISI	130°
MONTAJ ŞEKLİ	Sıva Üstü
ROZANS	15 - 20 - 25 - 30 Cm / Özel Ölçü Yapılır
UYGULAMA ALANLARI	Bina İç Mekan ve Ofis Aydınlatmaları

LKS - LNR - MOBİLYA 1

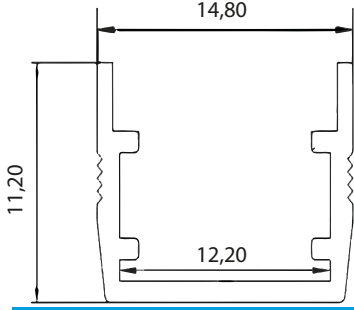

ÖZELLİKLER

Kasa	Eloksal Ekstruzyon Alüminyum
Cam	Polikarbon Opal
Işıma Açısı	130°
Montaj Şekli	Sıva üstü
Yan Kapak	Plastik geçmeli
Uygulama Alanları	Bina İç Mekan ve Mobilya Aydınlatmaları



Aksesuarlar

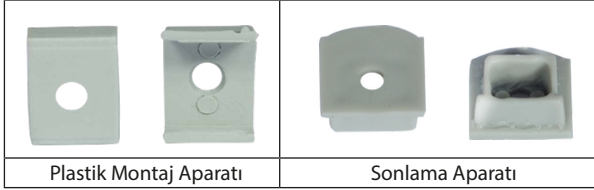

LKS - LNR - MOBİLYA 2

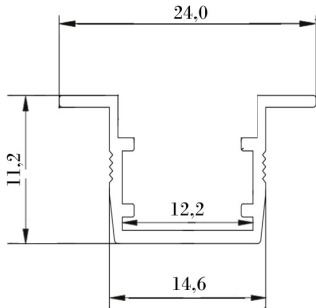

ÖZELLİKLER

Kasa	Eloksal Ekstruzyon Alüminyum
Cam	Polikarbon Opal
Işıma Açısı	130°
Montaj Şekli	Sıva altı
Yan Kapak	Plastik geçmeli
Uygulama Alanları	Bina İç Mekan ve Mobilya Aydınlatmaları

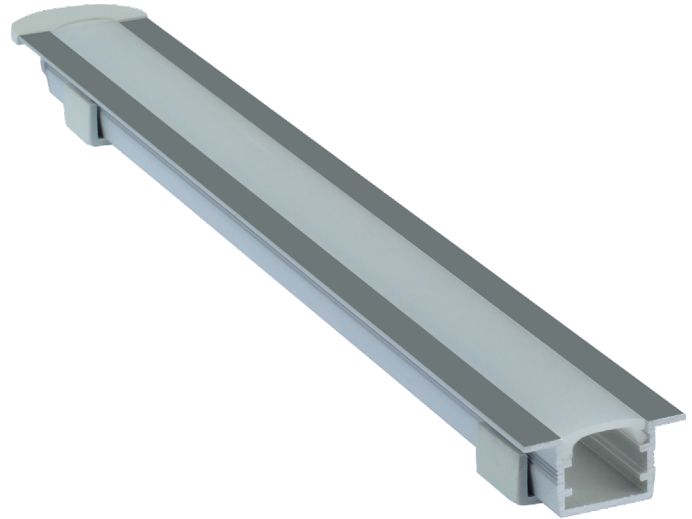

Aksesuarlar

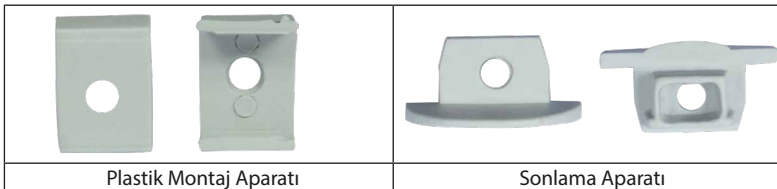

LKS - LNR - MOBİLYA 3

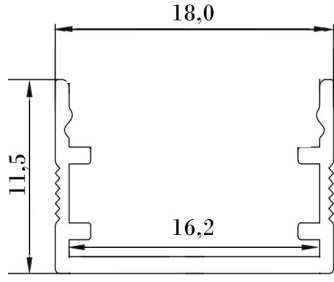

ÖZELLİKLER

Kasa	Eloksal Ekstruzyon Alüminyum
Cam	Polikarbon Opal
Işıma Açısı	130°
Montaj Şekli	Sıva üstü
Yan Kapak	Plastik geçmeli
Uygulama Alanları	Bina İç Mekan ve Mobilya Aydınlatmaları

Aksesuarlar



LKS - LNR - MOBİLYA 4

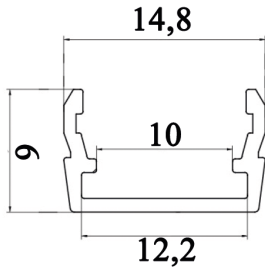

ÖZELLİKLER

Kasa	Eloksal Ekstruzyon Alüminyum
Cam	Polikarbon Opal
Işıma Açısı	130°
Montaj Şekli	Sıva üstü
Yan Kapak	Plastik geçmeli
Uygulama Alanları	Bina İç Mekan ve Mobilya Aydınlatmaları

Aksesuarlar

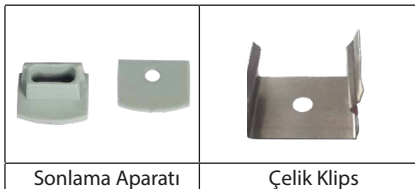

LKS - LNR - 11

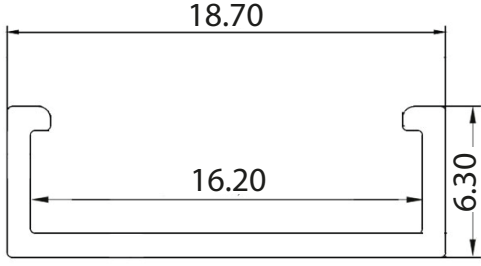

ÖZELLİKLER

Kasa	Eloksal Ekstruzyon Alüminyum
Cam	Polikarbon Opal
Işıma Açısı	130°
Montaj Şekli	Sıva üstü
Uygulama Alanları	Bina İç Mekan Aydınlatmaları



LKS - LNR - 12

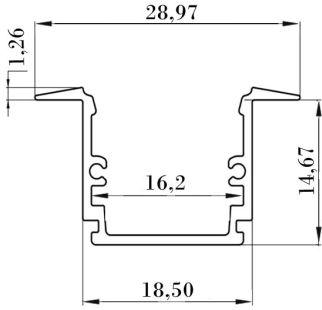

ÖZELLİKLER

Kasa	Eloksal Ekstruzyon Alüminyum
Cam	Polikarbon Opal
Işıma Açısı	130°
Montaj Şekli	Sıva Altı
Yan Kapak	Plastik geçmeli
Uygulama Alanları	Bina İç Mekan Aydınlatmaları



Aksesuarlar

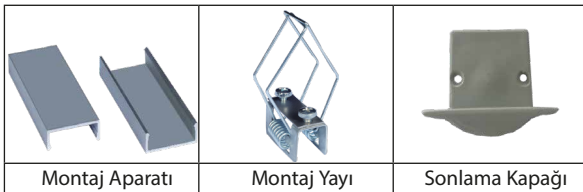

LKS - LNR - 13

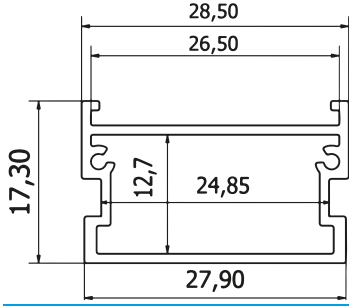

ÖZELLİKLER

Cam	Polikarbon
Montaj Şekli	Siva Üstü
Yan Kapak	Metal
Uygulama Alanları	İç Aydınlatma (Market, Tekstil, Mobilya ve Soğutucu Grup Reyonları)
Işıma Açısı	180°



LKS - LNR - 14

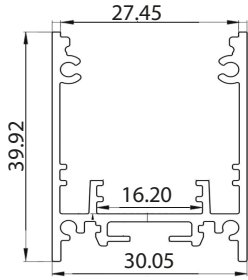

ÖZELLİKLER

Kasa	Eloksal Ekstrüzyon Alüminyum
Cam	Polikarbon Opal
Işıma Açısı	130°
Montaj Şekli	Siva Üstü / Sarkıt
Yan Kapak	Plastik geçmeli
Uygulama Alanları	Bina İç Mekan Aydınlatmaları

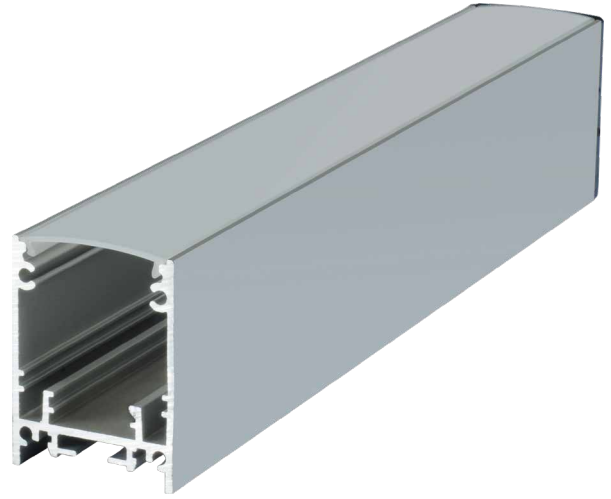

Aksesuarlar

Askı Teli	Askı Teli Montaj Aparatı	Setskurulu Siva Üstü Montaj Aparatı	Sıfır Montaj Aparatı	Sonlama Kapağı

LKS - LNR - 15

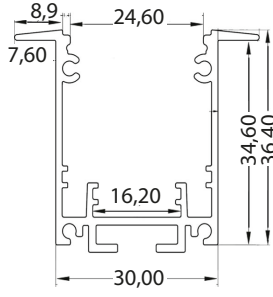

ÖZELLİKLER

Kasa	Eloksal Ekstrüzyon Alüminyum
Cam	Polikarbon Opal
Işıma Açısı	130°
Montaj Şekli	Sıva Altı
Yan Kapak	Plastik geçmeli
Uygulama Alanları	Bina İç Mekan Aydınlatmaları

Aksesuarlar

Montaj Yayı	Sonlama Kapağı

LKS - LNR - 16

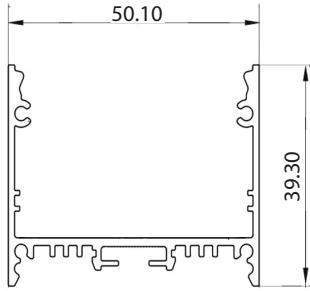

ÖZELLİKLER

Kasa	Eloksal Ekstrüzyon Alüminyum
Cam	Polikarbon Opal
Işıma Açısı	130°
Montaj Şekli	Sıva Üstü / Sarkıt
Yan Kapak	Plastik geçmeli
Uygulama Alanları	Bina İç Mekan Aydınlatmaları

Aksesuarlar

Aski Teli	Aski Teli Montaj Aparatı	Setskurulu Sıva Üstü Montaj Aparatı	Sıfır Montaj Aparatı	Köşe Birleştirme Aparatı	Sonlama Kapağı

LKS - LNR - 17

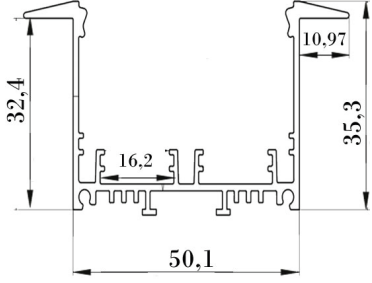

ÖZELLİKLER

Kasa	Eloksal Ekstruzyon Alüminyum
Cam	Polikarbon Opal
Işıma Açısı	130°
Montaj Şekli	Sıva Altı
Yan Kapak	Plastik geçmeli
Uygulama Alanları	Bina İç Mekan Aydınlatmaları

Aksesuarlar

Montaj Yayı	Sonlama Kapağı



Lnr-17 Kanalsız

LKS - LNR - 18

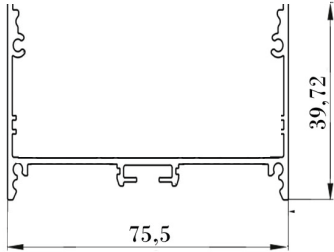

ÖZELLİKLER

Kasa	Eloksal Ekstruzyon Alüminyum
Cam	Polikarbon Opal
Işıma Açısı	130°
Montaj Şekli	Sıva Üstü /Sarkıt
Yan Kapak	Plastik geçmeli
Uygulama Alanları	Bina İç Mekan Aydınlatmaları

Aksesuarlar

Aski Teli	Aski Teli Montaj Aparatı	Setskurlu Sıva Üstü Montaj Aparatı	Sıfır Montaj Aparatı	Sonlama Kapağı



LKS - LNR - 19

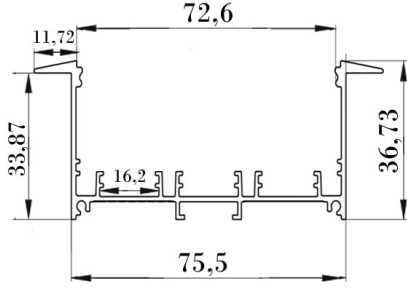

ÖZELLİKLER

Kasa	Eloksal Ekstruzyon Alüminyum
Cam	Polikarbon Opal
Işıma Açısı	130°
Montaj Şekli	Sıva Altı
Yan Kapak	Plastik geçmeli
Uygulama Alanları	Bina İç Mekan Aydınlatmaları

Aksesuarlar

Montaj Aparatı	Sonlama Kapağı



Lnr-19 Kanalsız

LKS - LNR - 20

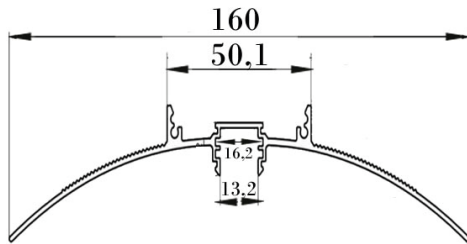

ÖZELLİKLER

Kasa	Eloksal Ekstruzyon Alüminyum
Cam	Polikarbon Opal
Işıma Açısı	130°
Montaj Şekli	Sıva Üstü / Sarkıt
Yan Kapak	Plastik geçmeli
Uygulama Alanları	Bina İç Mekan Aydınlatmaları

Aksesuarlar

Askı Teli	Askı Teli Montaj Aparatı	Setskurlu Sıva Üstü Montaj Aparatı	Sıfır Montaj Aparatı	Sürücü Yuvası	Sonlama Kapağı

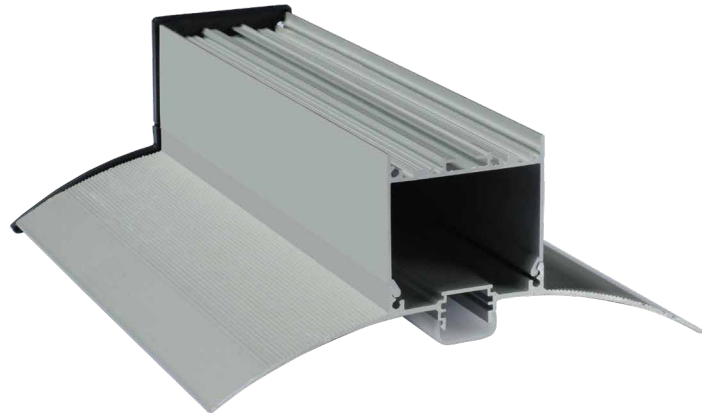

LKS - LNR - 21

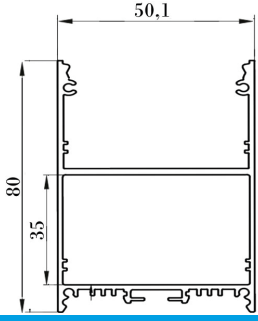

ÖZELLİKLER

Kasa	Eloksal Ekstruzyon Alüminyum
Cam	Polikarbon Opal
Işıma Açısı	130°
Montaj Şekli	Sıva Üstü / Sarkıt
Yan Kapak	Plastik geçmeli
Uygulama Alanları	Bina İç Mekan Aydınlatmaları

Aksesuarlar

Askı Teli	Askı Teli Montaj Aparatı	Setskurlu Sıva Üstü Montaj Aparatı	Sıfır Montaj Aparatı	Köşe Birleştirme Aparatı	Sonlama Kapağı

LKS - LNR - 21 İç Sürgülü

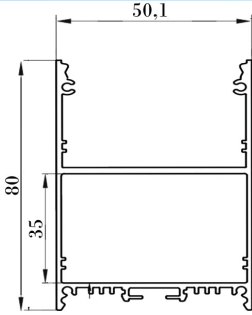

ÖZELLİKLER

Kasa	Eloksal Ekstruzyon Alüminyum
Cam	Polikarbon Opal
Işıma Açısı	130°
Montaj Şekli	Sıva Üstü /Sarkıt
Yan Kapak	Plastik geçmeli
Uygulama Alanları	Bina İç Mekan Aydınlatmaları

Aksesuarlar

Askı Teli	Askı Teli Montaj Aparatı	Setskurlu Sıva Üstü Montaj Aparatı	Sıfır Montaj Aparatı	Köşe Birleştirme Aparatı	Sonlama Kapağı

LKS - LNR - 21-B

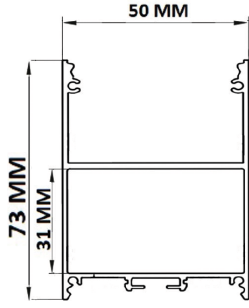

ÖZELLİKLER

Kasa	Eloksal Ekstruzyon Alüminyum
Cam	Polikarbon Opal
Işıma Açısı	130°
Montaj Şekli	Sıva Üstü / Sarkıt
Yan Kapak	Plastik geçmeli
Uygulama Alanları	Bina İç Mekan Aydınlatmaları

Aksesuarlar

Aski Teli	Aski Teli Montaj Aparatı	Setskurulu Sıva Üstü Montaj Aparatı	Sıfır Montaj Aparatı	Köşe Birleştirme Aparatı	Sonlama Kapağı

LKS-LNR-32

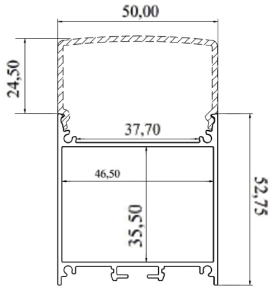

ÖZELLİKLER

Kasa	Eloksal Ekstruzyon Alüminyum
Cam	Polikarbon
Işıma Açısı	180°
Montaj Şekli	Sıva Üstü
Yan Kapak	Metal
Uygulama Alanları	Bina İç Mekan Aydınlatmaları

LKS - LNR - 22

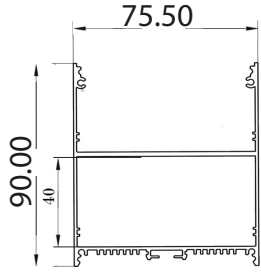

ÖZELLİKLER

Kasa	Eloksal Ekstruzyon Alüminyum
Cam	Polikarbon Opal
Işıma Açısı	130°
Montaj Şekli	Sıva Üstü / Sarkıt
Yan Kapak	Plastik geçmeli
Uygulama Alanları	Bina İç Mekan Aydınlatmaları

Aksesuarlar

Askı Teli	Askı Teli Montaj Aparatı	Setskurlu Sıva Üstü Montaj Aparatı	Sıfır Montaj Aparatı	Köşe Birleştirme Aparatı	Sonlama Kapağı

LKS - LNR - 23

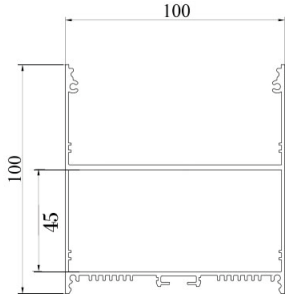

ÖZELLİKLER

Kasa	Eloksal Ekstruzyon Alüminyum
Cam	Polikarbon Opal
Işıma Açısı	130°
Montaj Şekli	Sıva Üstü / Sarkıt
Yan Kapak	Plastik geçmeli
Uygulama Alanları	Bina İç Mekan Aydınlatmaları

Aksesuarlar

Askı Teli	Askı Teli Montaj Aparatı	Setskurlu Sıva Üstü Montaj Aparatı	Sıfır Montaj Aparatı	Sonlama Kapağı

LKS - LNR - 24

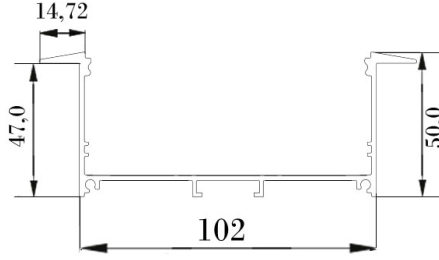

ÖZELLİKLER

Kasa	Eloksal Ekstruzyon Alüminyum
Cam	Polikarbon Opal
Işıma Açısı	130°
Montaj Şekli	Sıva Altı
Yan Kapak	Plastik geçmeli
Uygulama Alanları	Bina İç Mekan Aydınlatmaları



Aksesuarlar

Montaj Aparatı	Sonlama Kapağı

LKS - LNR - 25

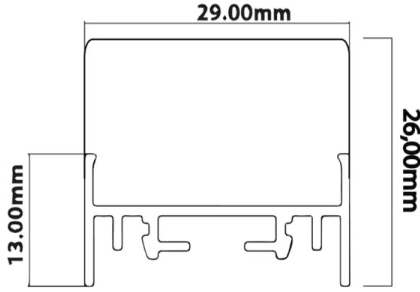

ÖZELLİKLER

Kasa	Eloksal Ekstruzyon Alüminyum
Cam	Polikarbon Opal
Işıma Açısı	180°
Montaj Şekli	Sıva Üstü /Sarkıt
Yan Kapak	Plastik geçmeli
Uygulama Alanları	Bina İç Mekan Aydınlatmaları



Aksesuarlar

Aski Teli	Aski Teli Montaj Aparatı	Setskurlu Sıva Üstü Montaj Aparatı	Sıfır Montaj Aparatı	Köşe Birleştirme Aparatı	Sonlama Kapağı

LKS - LNR - 26

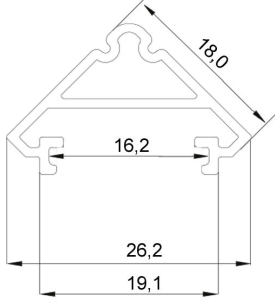

ÖZELLİKLER

Kasa	Eloksal Ekstruzyon Alüminyum
Cam	Polikarbon Opal
Işıma Açısı	130°
Montaj Şekli	Sıva Üstü
Yan Kapak	Plastik geçmeli
Uygulama Alanları	Bina İç Mekan Aydınlatmaları

Aksesuarlar

Sonlama Kapağı	Çelik Klips

LKS - LNR - 27

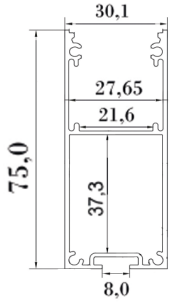

ÖZELLİKLER

Kasa	Eloksal Ekstruzyon Alüminyum
Cam	Polikarbon Opal
Işıma Açısı	130°
Montaj Şekli	Sıva Üstü / Sarkıt
Yan Kapak	Plastik geçmeli
Uygulama Alanları	Bina İç Mekan Aydınlatmaları

Aksesuarlar

Askı Teli	Askı Teli Montaj Aparatı	Setskurulu Sıva Üstü Montaj Aparatı	Köşe Birleştirme Aparatı	Sonlama Kapağı

LKS - LNR - 28

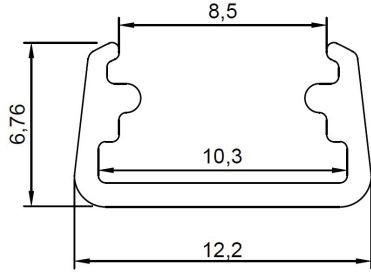

ÖZELLİKLER

Kasa	Eloksal Ekstruzyon Alüminyum
Cam	Polikarbon Opal
Işıma Açısı	130°
Montaj Şekli	Sıva Üstü
Yan Kapak	Plastik geçmeli
Uygulama Alanları	Bina İç Mekan Aydınlatmaları



Aksesuarlar



Sonlama Kapağı

LKS - LNR - 29 (Endirekt)

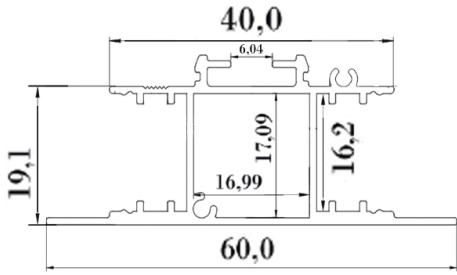

ÖZELLİKLER

Kasa	Eloksal Ekstruzyon Alüminyum
Cam	Polikarbon Opal
Işıma Açısı	130°
Montaj Şekli	Sıva Üstü /Sarkıt
Yan Kapak	Plastik geçmeli
Uygulama Alanları	Bina İç Mekan Aydınlatmaları



Aksesuarlar



LKS - LNR - 30

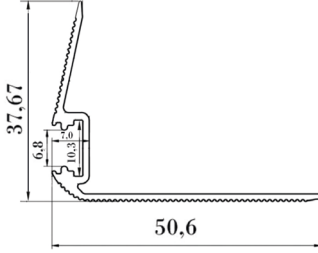

ÖZELLİKLER

Kasa	Eloksal Ekstrüzyon Alüminyum
Cam	Polikarbon Opal
Işıma Açısı	130°
Montaj Şekli	Sıva Üstü
Yan Kapak	Plastik geçmeli
Uygulama Alanları	Bina İç Mekan, Mobilya ve Merdiven Aydınlatmaları, Sinema Salon Merdiven Aydınlatması

Aksesuarlar

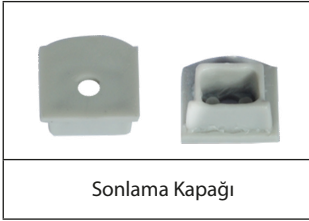

LKS - LNR - 31 (Endirekt)

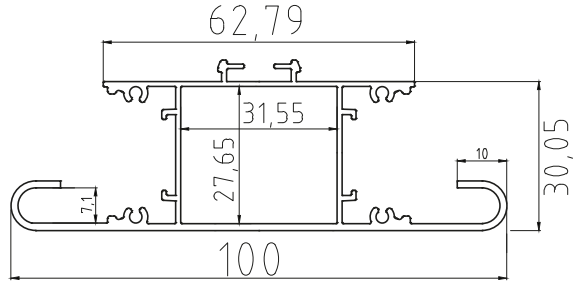

ÖZELLİKLER

Kasa	Eloksal Ekstrüzyon Alüminyum
Cam	Polikarbon Opal
Işıma Açısı	130°
Montaj Şekli	Sıva Üstü / Sarkıt
Yan Kapak	Plastik geçmeli
Uygulama Alanları	Bina İç Mekan Aydınlatmaları

Aksesuarlar



LKS - LNR - 33 (LED TÜP)

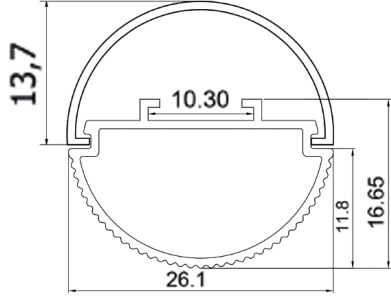

ÖZELLİKLER

Kasa	Eloksal Ekstruzyon Alüminyum
Cam	Polikarbon Opal
Montaj Şekli	Sıva Üstü
Yan Kapak	Plastik pimli
Uygulama Alanları	İç Mekan Aydınlatma
Ölçü	60 cm - 100 cm - 120 cm



LKS - LNR - EPOKSİ PROFİLİ

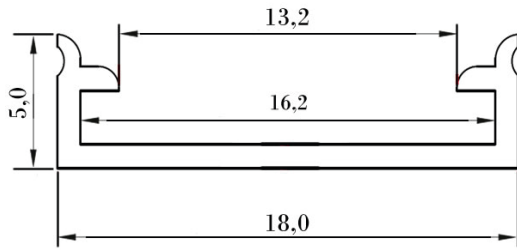

ÖZELLİKLER

Kasa	Eloksal Ekstruzyon Alüminyum
Işıma Açısı	132°
Montaj Şekli	Sıva üstü
Uygulama Alanları	Bina İç ve Dış Mekan Aydınlatmaları



LKS - LNR - 34

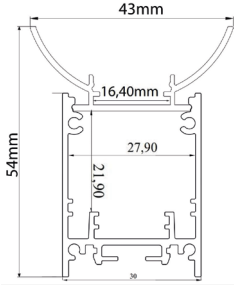

ÖZELLİKLER

Kasa	Eloksal Ekstruzyon Alüminyum
Cam	Polikarbon Opal
Montaj Şekli	Sıva Üstü
Yan Kapak	Plastik pimli
Uygulama Alanları	İç Mekan ve Market Aydınlatma
Ölçü	60 cm - 100 cm - 120 cm



LKS - LNR - 35

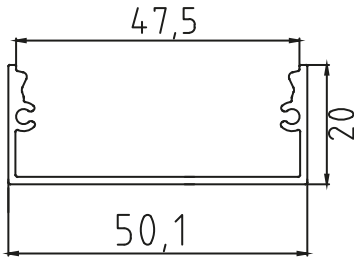

ÖZELLİKLER

Kasa	Eloksal Ekstruzyon Alüminyum
Cam	Polikarbon Opal
Montaj Şekli	Sıva Üstü
Yan Kapak	Metal
Uygulama Alanları	İç Mekan ve Market Aydınlatma
Ölçü	60 cm - 100 cm - 120 cm



LKS - LNR - 36 (LED TÜP)

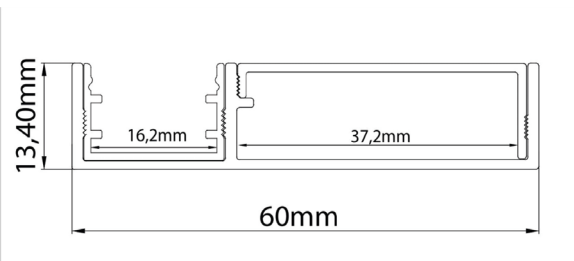

ÖZELLİKLER

Kasa	Eloksal Ekstruzyon Alüminyum
Cam	Polikarbon Opal
Montaj Şekli	Sıva Üstü
Yan Kapak	Metal
Uygulama Alanları	İç Mekan, Mobilya ve Merdiven Aydınlatma
Ölçü	60 cm - 100 cm - 120 cm



LKS-WLW-01

ÖZELLİKLER

KASA	Eloksal Ekstruzyon Alüminyum
CAM	Cam Tedariğimiz Yoktur
İŞİMA AÇISI	130°
MONTAJ ŞEKLİ	Sıva Üstü
YAN KAPAK	Plastik geçmeli
UYGULAMA ALANLARI	Bina İç ve Dış Mekan Aydınlatmaları

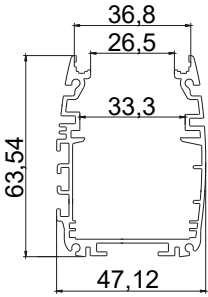

Aksesuarlar

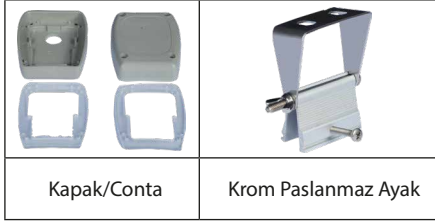

LKS-WLW-02

ÖZELLİKLER

KASA	Eloksal Ekstruzyon Alüminyum
LENS	30° - 60° - 90°
İŞİMA AÇISI	130°
MONTAJ ŞEKLİ	Sıva Üstü / Sarkıt
YAN KAPAK	Plastik geçmeli
UYGULAMA ALANLARI	Bina İç ve Dış Mekan Aydınlatmaları

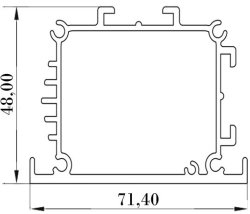

Aksesuarlar

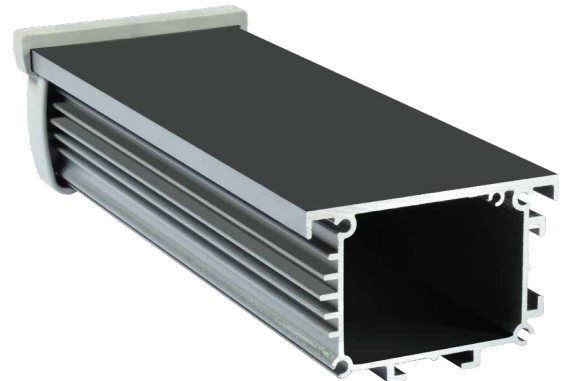

LKS-WLW-03

ÖZELLİKLER

KASA	Eloksal Ekstruzyon Alüminyum
CAM	Polikarbon Opal
İŞİMA AÇISI	130°
MONTAJ ŞEKLİ	Sıva üstü
YAN KAPAK	Plastik geçmeli
UYGULAMA ALANLARI	Bina İç ve Dış Mekan Aydınlatmaları

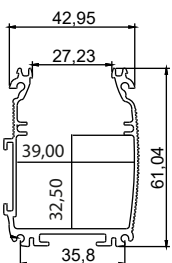

Aksesuarlar



LKS-ETANJ-1

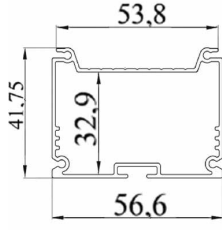

ÖZELLİKLER

Kasa	Eloksal Ekstruzyon Alüminyum
Cam	Polikarbon Opal / Şeffaf Seçeneğimiz Mevcuttur.
Işıma Açısı	180°
Montaj Şekli	Sıva Üstü / Sarkıt
Yan Kapak	Plastik geçmeli
Uygulama Alanları	Bina İç ve Dış Mekan Aydınlatma



Aksesuarlar

Montaj Aparatı	Sonlama Kapağı

Etanj Alüminyum Bant Armatür

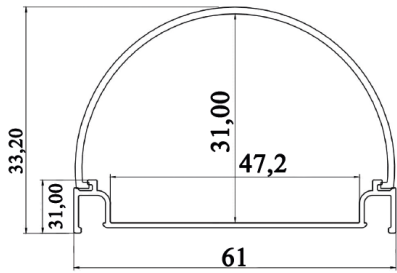

ÖZELLİKLER

Kasa	Eloksal Ekstruzyon Alüminyum
Cam	Polikarbon
Işıma Açısı	180°
Montaj Şekli	Sıva Üstü
Yan Kapak	Plastik
Uygulama Alanları	Bina iç mekan ve otopark aydınlatmaları



LKS-LNR-P60

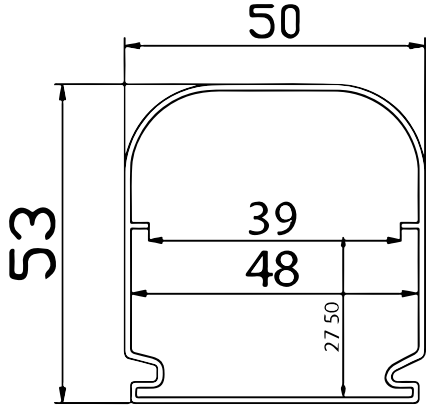

ÖZELLİKLER

Kasa	Polikarbon (Coex Kalıp)
Led Sürgü Kanalı	Alüminyum Profil
Montaj Şekli	Sıva Üstü
Yan Kapak	Plastik Contalı Kapak
Uygulama Alanları	İç ve Dış Mekan (Otopark)
Ölçü	60 cm - 120 cm



LKS-LNR-P50

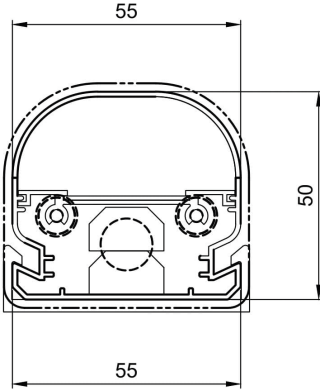

ÖZELLİKLER

Kasa	Polikarbon (Coex Kalıp)
Led Sürgü Kanalı	Alüminyum Profil
Montaj Şekli	Sıva Üstü
Yan Kapak	Plastik Contalı Kapak
Uygulama Alanları	İç ve Dış Mekan (Otopark)
Ölçü	60 cm - 120 cm



LKS-LNR-P40 (POLİKARBON BANT ARMATÜR)

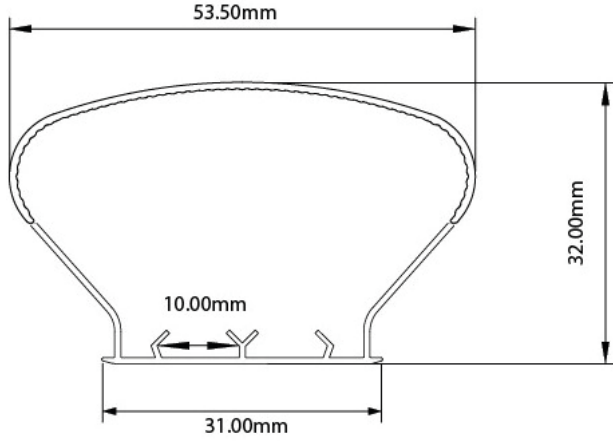

ÖZELLİKLER

Kasa	Polikarbon (Coex Kalıp)
Led Sürgü Kanalı	Polikarbon
Montaj Şekli	Sıva Üstü
Yan Kapak	Plastik Sıkı Geçme
Uygulama Alanları	İç Aydınlatma (Market, Tekstil, Mobilya ve Soğutucu Grup Reyonları)
Ölçü	120 cm

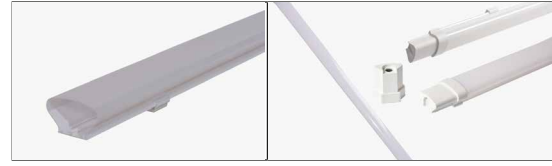

LKS-LNR-P30

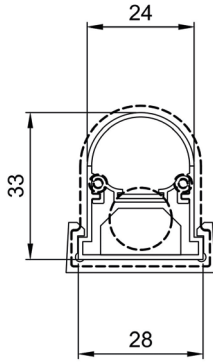

ÖZELLİKLER

Kasa	Polikarbon (Coex Kalıp)
Led Sürgü Kanalı	Alüminyum Profil
Montaj Şekli	Sıva Üstü
Yan Kapak	Plastik Contalı Kapak
Uygulama Alanları	İç ve Dış Aydınlatma (Market, Tekstil, Mobilya ve Soğutucu Grup Reyonları)
Ölçü	60 cm - 100 cm - 120 cm



LKS-LNR-P20

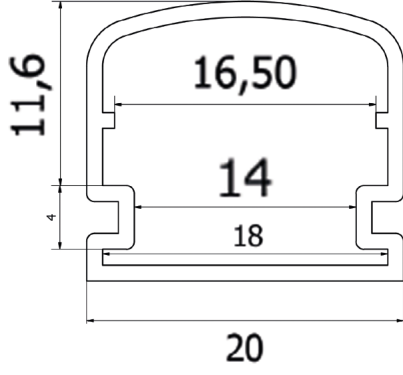

ÖZELLİKLER

Kasa	Polikarbon (Coex Kalıp)
Led Sürgü Kanalı	Alüminyum Profil
Montaj Şekli	Sıva Üstü
Yan Kapak	Plastik Contalı Kapak
Uygulama Alanları	İç ve Dış Aydınlatma (Market, Tekstil, Mobilya ve Soğutucu Grup Reyonları)
Ölçü	60 cm - 100 cm - 120 cm



LKS-LNR-P10

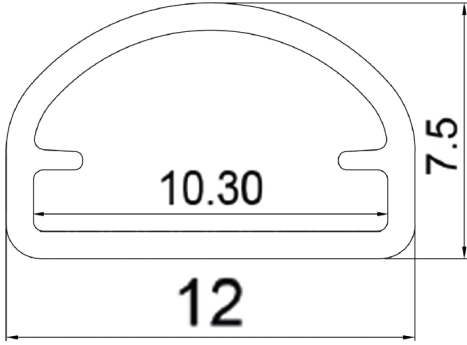

ÖZELLİKLER

Kasa	Polikarbon (Coex Kalıp)
Montaj Şekli	Sıva Üstü
Yan Kapak	Plastik
Uygulama Alanları	Bina İç, Dış Mekan ve Mobilya Aydınlatmaları
Ölçü	60 cm - 100 cm - 120 cm



LKS-LNR-T1

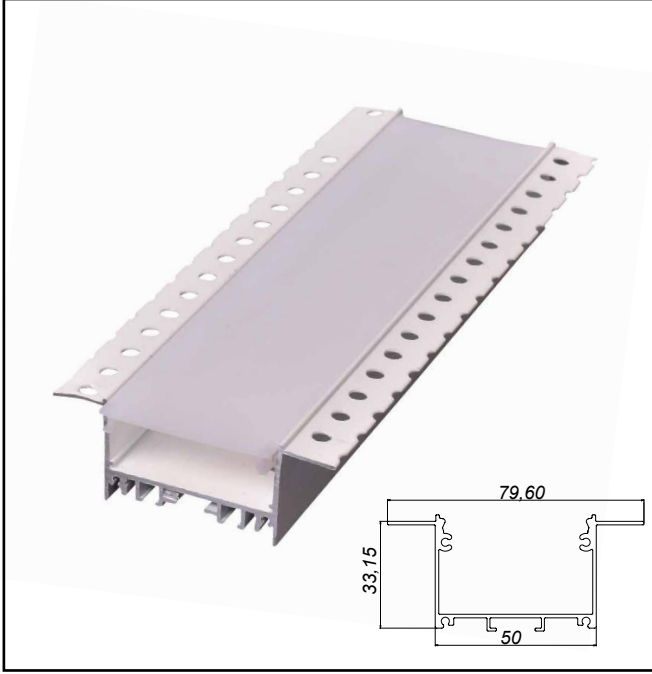

LKS-LNR-T2

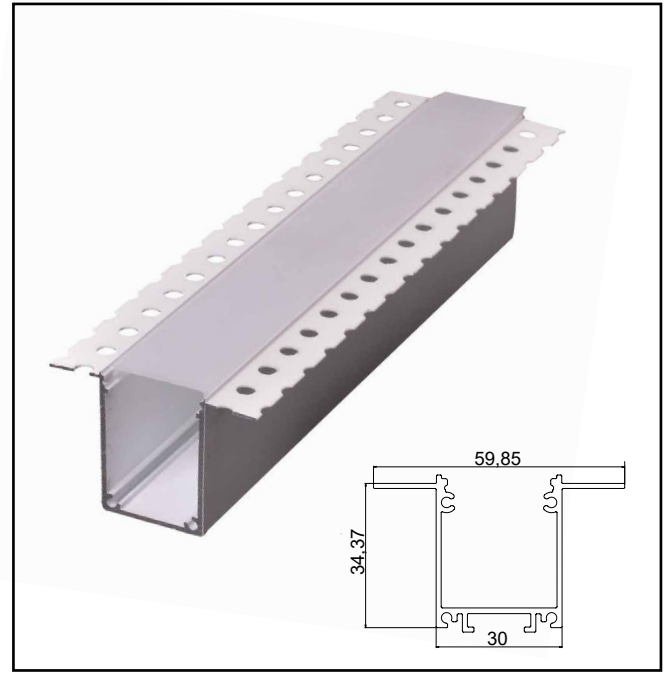

LKS-LNR-T3

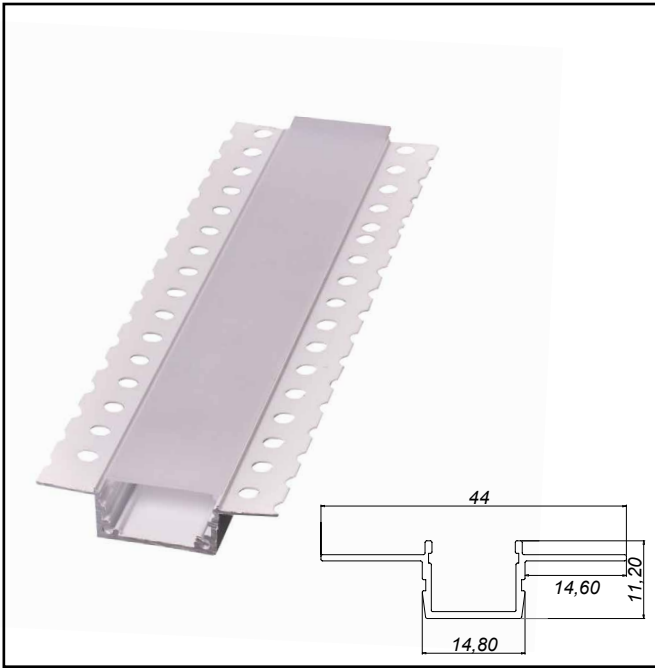

ÖZELLİKLER

KASA	Eloksal Ekstruzyon Alüminyum
DİFFÜZÖR	Polikarbon
İŞİMA AÇISI	130°
MONTAJ ŞEKLİ	Sıva Üstü
UYGULAMA ALANLARI	Bina İç Mekan ve Ofis Aydınlatmaları

LKS-PR4-200-300-WATT

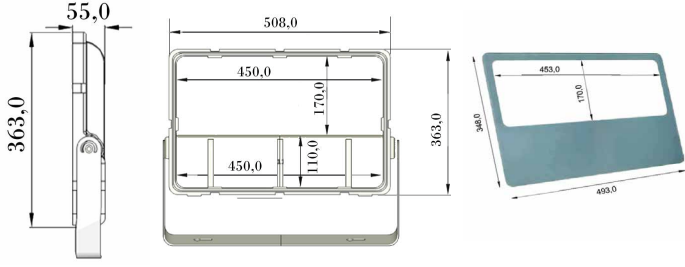

ÖZELLİKLER

KASA	Metal Enjeksiyon Alüminyum Gövde
CAM	4 mm Temperli Cam
IŞIMA AÇISI	130°
AĞIRLIK	5,5 Kg
UYGULAMA ALANLARI	Yol ve Çevre Aydınlatmaları



Aksesuarlar

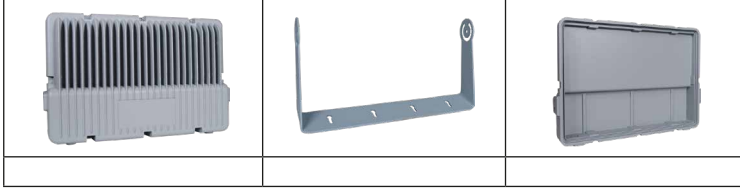

LKS-PR2-100-200-WATT

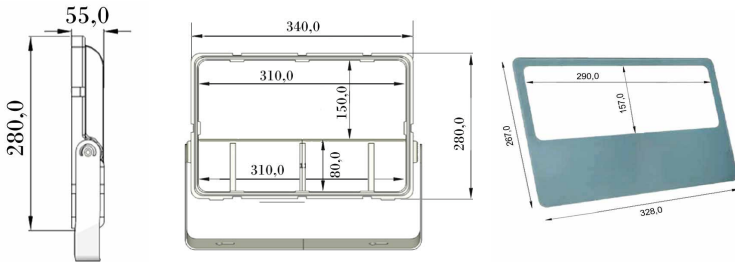

ÖZELLİKLER

KASA	Metal Enjeksiyon Alüminyum Gövde
CAM	4 mm Temperli Cam
IŞIMA AÇISI	130°
AĞIRLIK	4 Kg
UYGULAMA ALANLARI	Yol ve Çevre Aydınlatmaları



Aksesuarlar

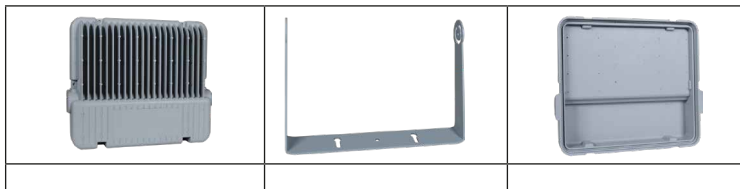

LKS-PR1-20-100-WATT

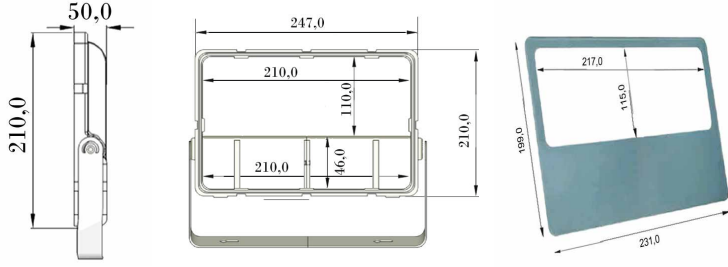

ÖZELLİKLER

KASA	Metal Enjeksiyon Alüminyum Gövde
CAM	4 mm Temperli Cam
İŞİMA AÇISI	130°
AĞIRLIK	1,60 Kg
UYGULAMA ALANLARI	Yol ve Çevre Aydınlatmaları



Aksesuarlar

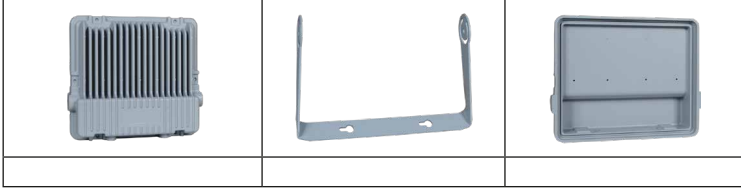

Lks-Sk-Pr-20-100-Watt

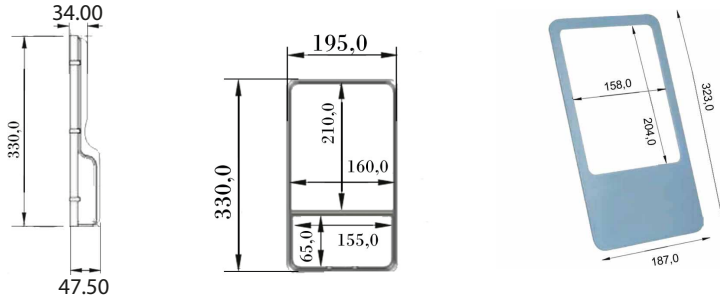

ÖZELLİKLER

KASA	Metal Enjeksiyon Alüminyum Gövde
CAM	4 mm Temperli Cam
İŞİMA AÇISI	130°
AĞIRLIK	1,65 Kg
UYGULAMA ALANLARI	Yol ve Çevre Aydınlatmaları



Aksesuarlar

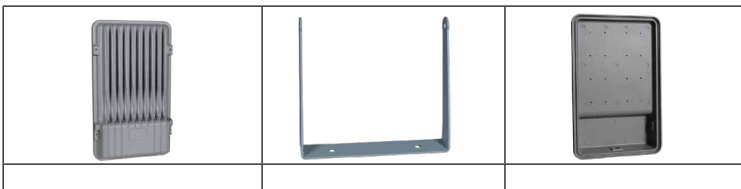

LKS-SKL1-20-80-WATT

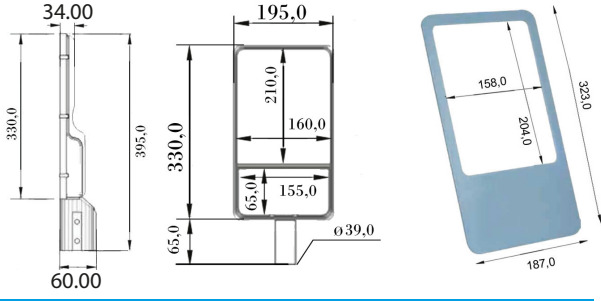

ÖZELLİKLER

KASA	Metal Enjeksiyon Alüminyum Gövde
CAM	4 mm Temperli Cam
İŞİMA AÇISI	130°
AĞIRLIK	1,65 Kg
UYGULAMA ALANLARI	Yol ve Çevre Aydınlatmaları



Aksesuarlar



Lks-Skl1-20-80-Watt-Q-65

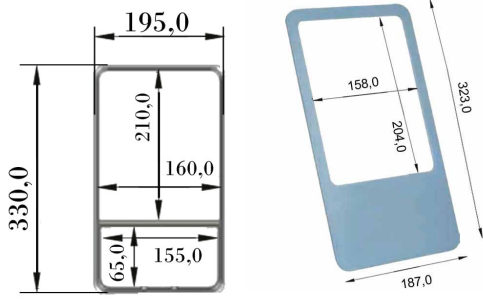

ÖZELLİKLER

KASA	Metal Enjeksiyon Alüminyum Gövde
CAM	4 mm Temperli Cam
İŞİMA AÇISI	130°
AĞIRLIK	1,70 Kg
UYGULAMA ALANLARI	Yol ve Çevre Aydınlatmaları

Aksesuarlar



Lks-Skl2-100-200-Watt

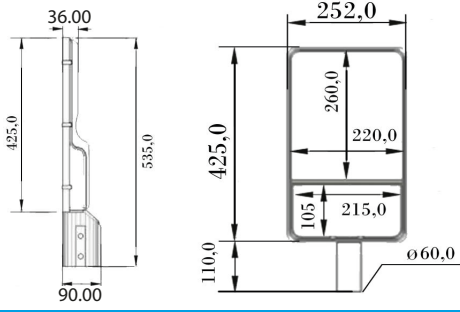

ÖZELLİKLER

KASA	Metal Enjeksiyon Alüminyum Gövde
CAM	4 mm Temperli Cam
İŞİMA AÇISI	130°
AĞIRLIK	3,75 Kg
UYGULAMA ALANLARI	Yol ve Çevre Aydınlatmaları



Aksesuarlar



LKS-HRK-SKL3 100-250w

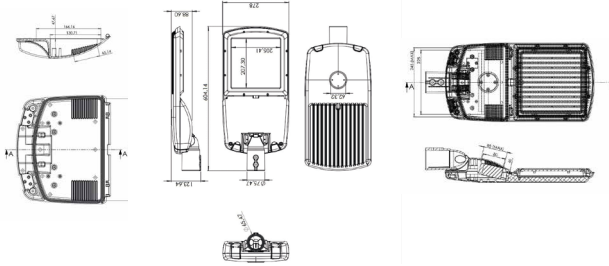

ÖZELLİKLER

CAM	5 mm TEMPERLİ CAM
MONTAJ ŞEKLİ	AYDINLATMA DİREKLERİ İÇİN UYGUNDUR
UYGULAMA ALANLARI	YOL, CADDE ve ÇEVRE AYDINLATMASI
KASA AÇI ARALIĞI	0-15 DERECE +-



Aksesuarlar



LKS - KNP - 150 - WATT

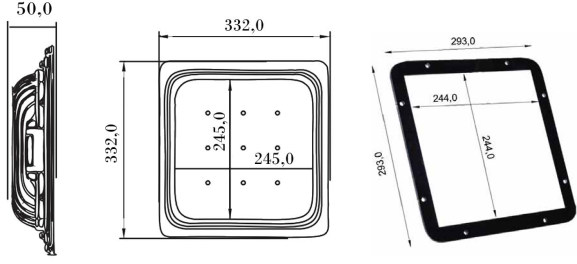

ÖZELLİKLER

KASA	Metal Enjeksiyon Alüminyum Gövde
CAM	4 mm Temperli Cam
İŞİMA AÇISI	130°
AĞIRLIK	4 Kg
MONTAJ ŞEKLİ	Sıva Altı
UYGULAMA ALANLARI	Petrol Ofisleri

Aksesuarlar



LKS-UFO-YTA

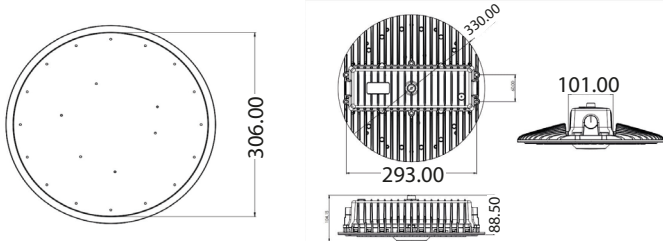

ÖZELLİKLER

KASA	ALÜMİNYUM ENJEKSİYON
LENS	33°x120° - 90°x145° - 60°x130° - 150°x160° - 85°x120° - 95°x155°
MONTAJ ŞEKLİ	SIVA ÜSTÜ / SARKIT
UYGULAMA ALANLARI	FABRİKA YÜKSEK TAVAN / İÇ VE DIŞ MEKAN
ÖLÇÜ	ÇAP 30 CM
KASA AÇI ARALIĞI	-45 VE +45 DERECE

Aksesuarlar



LKS-KRE-YTA-150-Watt

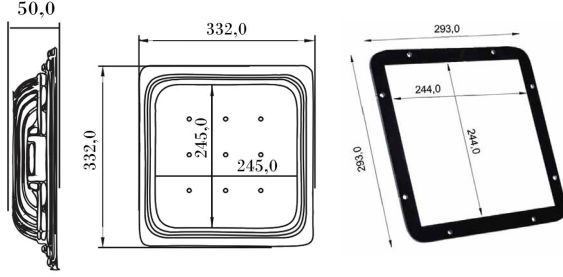

ÖZELLİKLER

CAM	4 mm Temperli Cam
IŞIMA AÇISI	130°
AĞIRLIK	4 kg
MONTAJ ŞEKLİ	Sıva Üstü
UYGULAMA ALANLARI	Yol ve Çevre Aydınlatmaları

Aksesuarlar

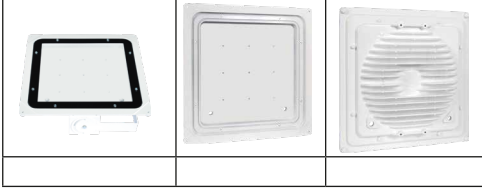

LKS-LNR-YTA

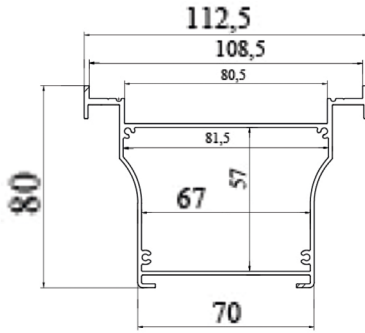

ÖZELLİKLER

CAM	4 mm Temperli Cam
IŞIMA AÇISI	130°
KASA	Eloksal Ekstrüzyon Alüminyum
MONTAJ ŞEKLİ	Sıva Üstü
UYGULAMA ALANLARI	Fabrika Yüksek Tavan
YAN KAPAK	Metal / Plastik



LKS-HLK-01



LKS-DVL-02



LKS-UCG-01



LKS-UCG-02

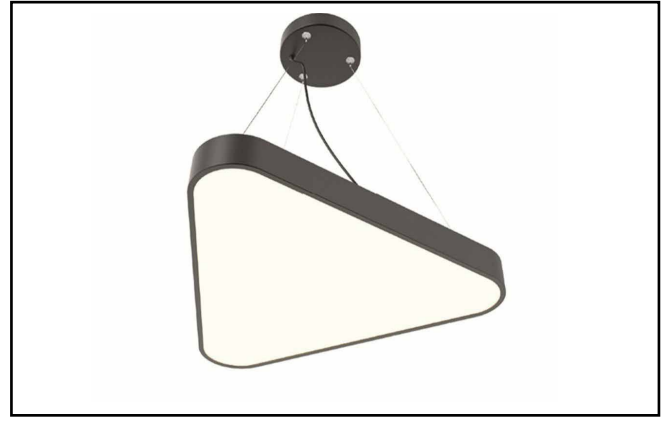

LKS-Y-ARM

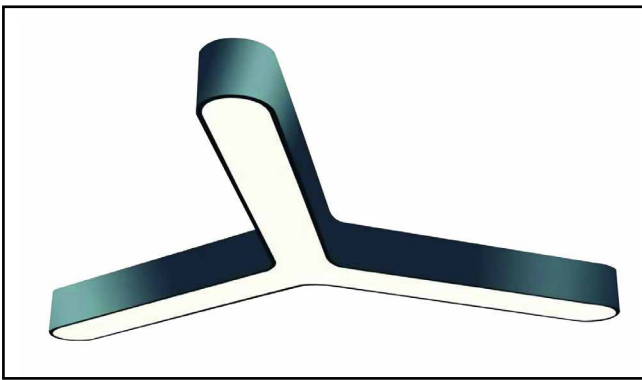

LKS-YRM-AY

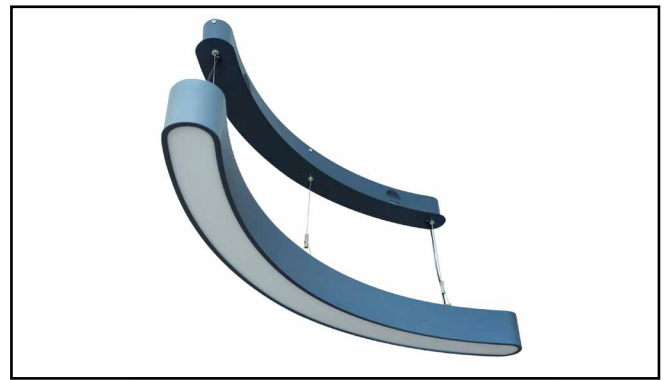

ÖZELLİKLER

KASA	Eloksal Ekstruzyon Alüminyum / Özel Büküm
PS UV LED DİFFÜZÖR LEVHA	Polistren
İŞİMA AÇISI	130°
MONTAJ ŞEKLİ	Sıva Altı ve Sıva Üstü Seçenekleri İle
ROZANS	15 - 20 - 25 - 30 Cm / Özel Ölçü Yapılır
UYGULAMA ALANLARI	Bina İç Mekan ve Ofis Aydınlatmaları
ÖLÇÜ	Yükseklik (H) 4,5 - 8 - 10 - 12 Cm

Aksesuarlar



Askı Teli

LKS-KRE-01

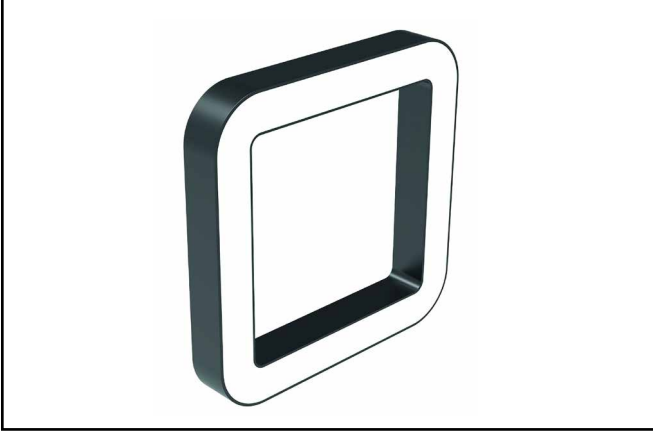

LKS-KRE-02



LKS-S-ARM

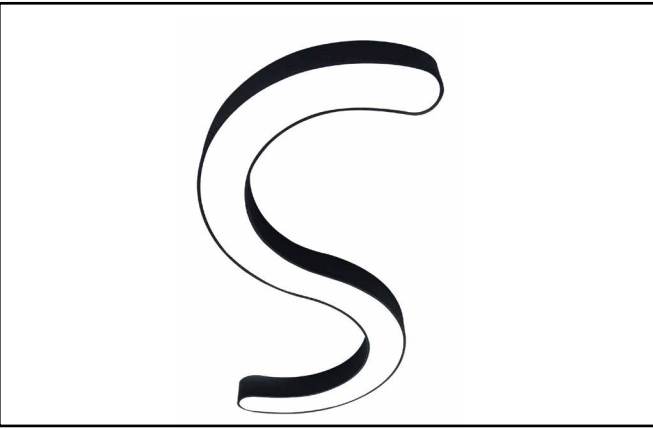

LKS-SYL-ARM

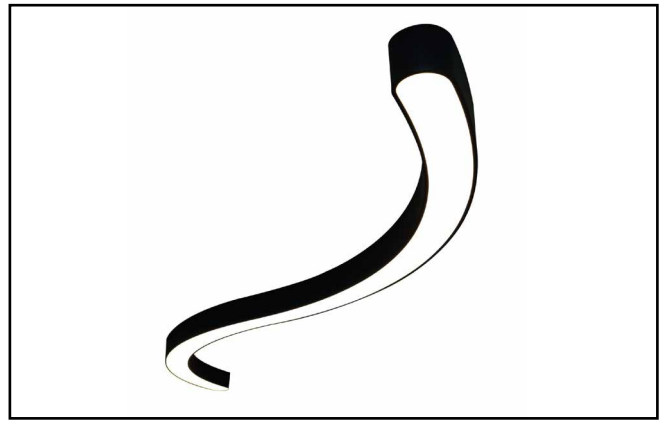

LKS-C-ARM

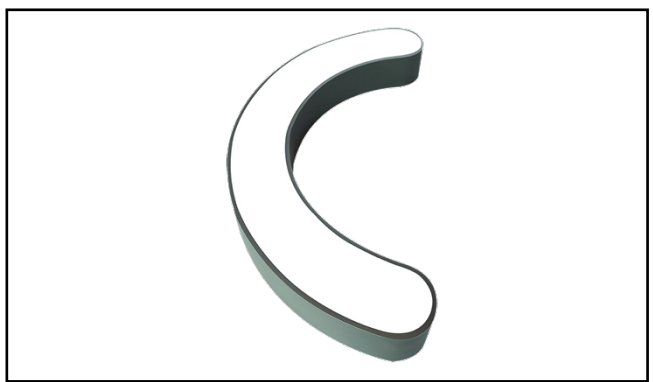

LKS-ELP-ARM

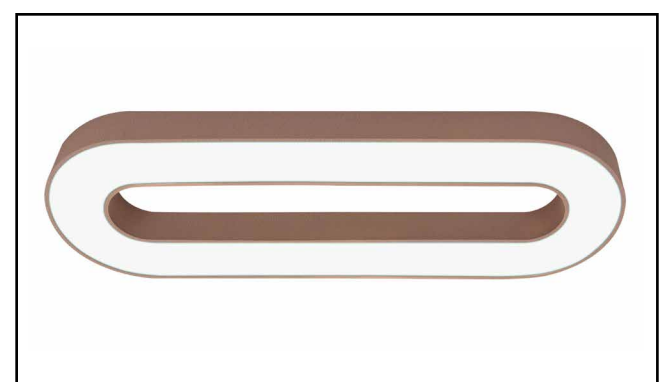

ÖZELLİKLER

KASA	Eloksal Ekstruzyon Alüminyum / Özel Büküm
PS UV LED DİFFÜZÖR LEVHA	Polistren
İŞİMA AÇISI	130°
MONTAJ ŞEKLİ	Sıva Altı ve Sıva Üstü Seçenekleri İle
ROZANS	15 - 20 - 25 - 30 Cm / Özel Ölçü Yapılır
UYGULAMA ALANLARI	Bina İç Mekan ve Ofis Aydınlatmaları
ÖLÇÜ	Yükseklik (H) 4,5 - 8 - 10 - 12 Cm

Aksesuarlar



Askı Teli

LKS-ATG-01

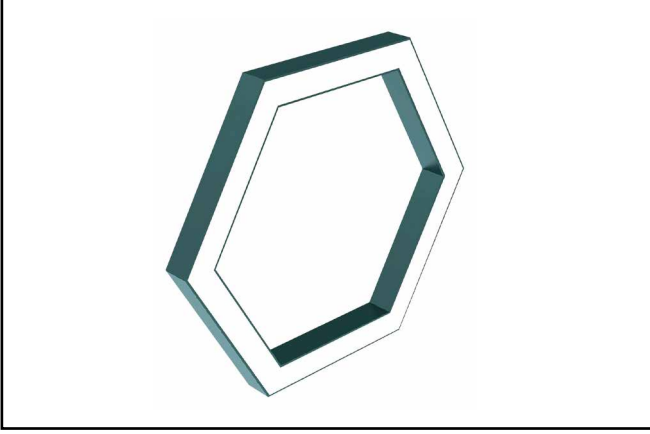

LKS-ATG-02

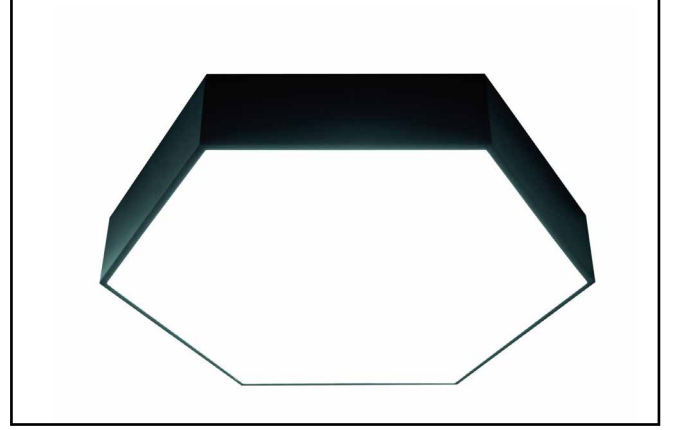

LKS-UCG-8X35İ

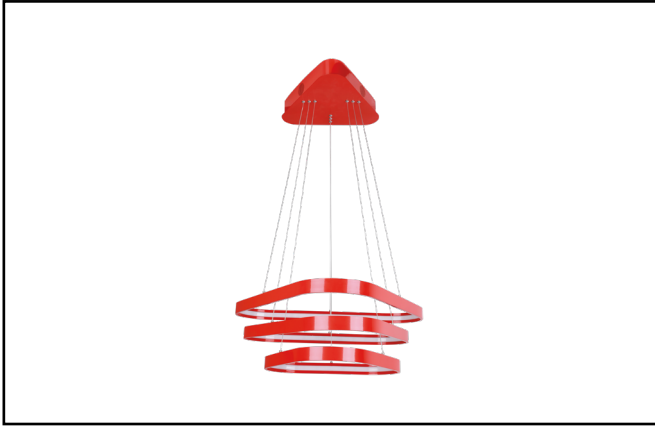

LKS-HLK-8X35

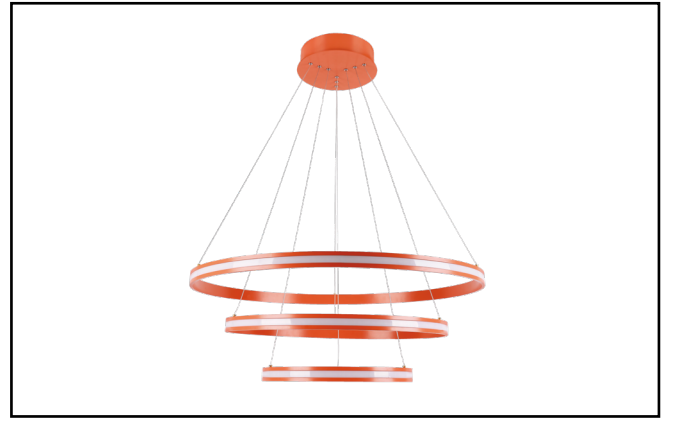

LKS-KRE-8X35



LKS-KRE-75X30

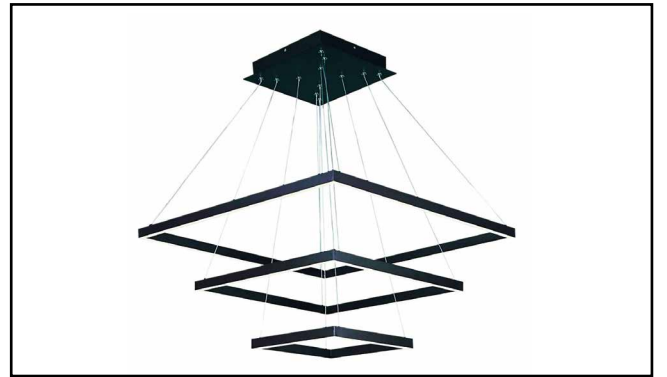

ÖZELLİKLER

KASA	Eloksal Ekstruzyon Alüminyum / Özel Büküm
PS UV LED DİFFÜZÖR LEVHA	Polistren - Polikarbon Opal
İŞİMA AÇISI	130°
MONTAJ ŞEKLİ	Sıva Üstü / Sarkıt
ROZANS	15 - 20 - 25 - 30 Cm / Özel Ölçü Yapılır
UYGULAMA ALANLARI	Bina İç Mekan ve Ofis Aydınlatmaları
ÖLÇÜ	Yükseklik (H) 4,5 - 8 - 10 - 12 cm

Aksesuarlar



Askı Teli

ZİL

LED KASA SİSTEMLERİ

LED

KASALAR



+90 216 379 00 96
+90 543 295 78 83
+90 544 295 78 84



info@ledkasalar.com
info@zriledkasasistemleri.com



Showroom:Çınardere mh. Özçelik sk.
no:15/A Pendik/İSTANBUL
Depo:Çınardere mh. Özçelik sk.
no:13/B Pendik/İSTANBUL

ZRL
LED KASA SİSTEMLERİ

LED
KASALAR